



# OCO BIOMEDICAL

THE NEXT GENERATION IN DENTAL IMPLANT TECHNOLOGY



2010 - 2011 PRODUCT CATALOG



# [TABLE OF CONTENTS]

CORPORATE OVERVIEW ..... 3

IMPLANT TECHNOLOGY ..... 4

OCO IMPLANT PRODUCT GUIDE ..... 5

I-MICRO IMPLANTS ..... 6

I-MINI® - IMMEDIATE MINI IMPLANT ..... 8

ISI COMPLETE® - IMMEDIATE STABILIZING IMPLANT ..... 10

TSI - TWO-PIECE TAPER SCREW IMPLANT ..... 12

ERI - ESTHETIC REGION IMPLANT ..... 14

IMPLANT PLACEMENT KITS ..... 16

INSTRUMENTATION ..... 17-18

ABUTMENTS ..... 19-20

RESTORATIVE ..... 21-22

CASTABLE COMPONENTS ..... 23-24

AIT - NATURAL TOOTH ROOT OVERDENTURE ATTACHMENT ..... 25

ADDITIONAL PRODUCTS ..... 26

QUESTIONS & ANSWERS ..... 27

Product images on the following pages are not necessarily to scale.



# [CORPORATE OVERVIEW]

## *The Next Generation in Dental Implant Technology™.*

### OCO BIOMEDICAL: DRIVING INNOVATION IN IMPLANTS

Since 1977, OCO Biomedical has raised the bar of excellence within the field of dentistry by producing state-of-the-art, user-friendly dental implant solutions. Today, we continue to manufacture superior dental implants and attachment systems and are leading the industry with The Next Generation in Dental Implant Technology™. We are dedicated to meeting the ever-evolving needs of our customers and continue to deliver innovative products while supplying only the best customer care.

OCO Biomedical, formerly known as the “O” Company, truly revolutionized the overdenture stabilization market when we introduced our patented O-Ball/O-Ring attachment system for removable prosthesis in 1980. After years of constructing subperiosteals and manufacturing blade implants, we developed our first press fit, root form cylinder implant in 1987. Throughout the 1990s, OCO worked diligently with dental implantologists to produce subsequent generations of innovative dental implants that met the needs of a growing dental implant community. In 2001, we were the first implant company to develop a one-piece 3.0mm mini implant and, presently, we are the only company to manufacture immediate load implants that form a biomechanical lock during placement by way of Dual Stabilization®.

OCO is proud to deliver an implant product line that is designed specifically to increase procedural and functional performance and enhance overall implant success rates. Designed for immediate or conventional (delayed) loading, OCO Biomedical’s Dual Stabilization® Dental Implant System is simple and minimally invasive. It can be used for simple implant procedures but is versatile enough to address even the most complicated of cases. Because our products are so versatile, they truly meet the needs of general practitioners and specialists alike.

### VISION AND MISSION STATEMENT

OCO Biomedical, Inc. aims to be the worldwide market leader in dental implantology by creating and supplying the most innovative, effective, and user-friendly dental implant products. Our technology is superior and our solutions truly meet the ever-changing needs of our customers. Additionally, we offer dentists a valuable educational experience through our dental implant training seminars and always guarantee personalized customer service and technical support.

We strive to be the partner of choice for General Dentists and Dental Specialists by providing the most innovative, reliable, and cost-effective implants that boast extraordinary success rates in the field of dental implantology.

Designed and manufactured in the USA. 



**OCO BIOMEDICAL**

# [ Implant Technology ]

## *The Next Generation of Dental Implant Technology™*



### The OCO Biomedical Logical Progression™

In the future, the standard dental implant system will have minimal placement/restorative instrumentation, and one universal implant body to fulfill all surgical needs.

These standards can be found today in OCO Biomedical's implant placement system that allows you to easily progress from our I-Micro to larger diameter implants (ISI/TSI/ERI) while using only one special side cutting osteotomy former and our proven bone condensing implant body.

With the OCO system, you can have a flap or flapless surgery and you don't need multiple twists,

intermediate drills, or taps; and you don't need a mount to thread-in our implants.

To learn more about our Logical Progression program visit [ocobiomedical.com/logicalprogression](http://ocobiomedical.com/logicalprogression)



# [OCO IMPLANTS]

The Next Generation of Dental Implant Technology™



## I-MICRO

### IMMEDIATE MICRO IMPLANT

Smaller diameter yet aggressive mini implant for thin ridge patients.

Implants	Page 6
Instrumentation	Page 17
Restorative	Page 22



## I-MINI®

### IMMEDIATE MINI IMPLANT

A proven mini implant perfect for crown & bridge or endentulous cases.

Implants	Page 8
Instrumentation	Page 17
Restorative	Page 22



## ISI COMPLETE®

### IMMEDIATE STABILIZING IMPLANT

A one piece solution for single tooth replacement & denture stabilization.

Implants	Page 10
Instrumentation	Page 17
Restorative	Page 22



## TSI

### TWO PIECE TAPER SCREW IMPLANT

Our distinct two piece implant body with dozens of prosthetic options.

Implants	Page 12
Instrumentation	Page 17
Abutments	Page 19
Restorative	Page 22



## ERI

### ESTHETIC REGION IMPLANT

The best possible esthetic implant solution for anterior cases.

Implants	Page 14
Instrumentation	Page 17
Abutments	Page 19
Restorative	Page 22

# [I-MICRO]

IMMEDIATE MICRO IMPLANT



## **The 2.2 & 2.5mm I-Micro**

The newest mini implant product from OCO Biomedical. The 2.2 & 2.5mm I-Micro is a one-piece implant precision machined out of titanium alloy with threads finished with our proprietary surface treatment. With a machined, not polished, collar the I-Micro is also engineered with an aggressive thread pattern for initial stability.

Because the I-Micro is compatible with our competitor's wrenches and drivers it is the perfect mini alternative without the costly investment of new instrumentation. The I-Micro is the first step in the Logical Progression to placing OCO's larger diameter one-piece implants: the I-Mini® and ISI Complete®; as well as the TSI and ERI two-piece implants.

## IMMEDIATE MICRO IMPLANTS

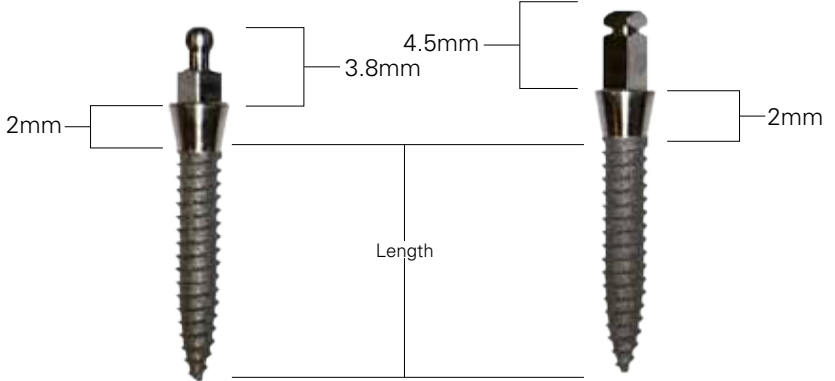
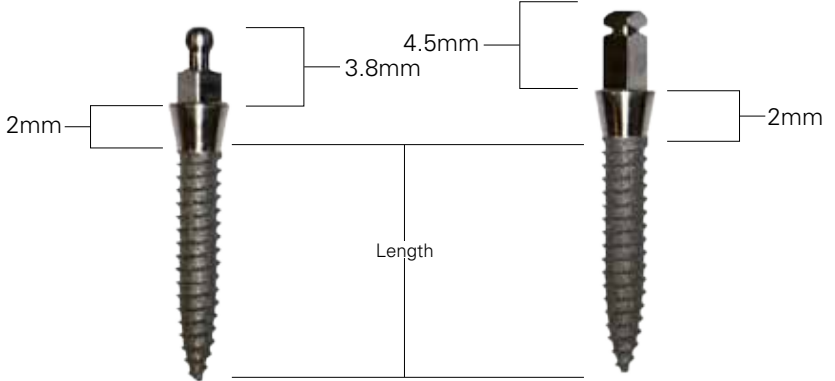
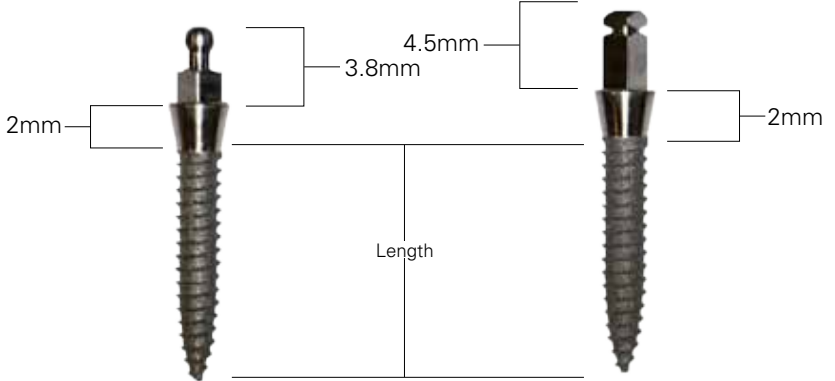
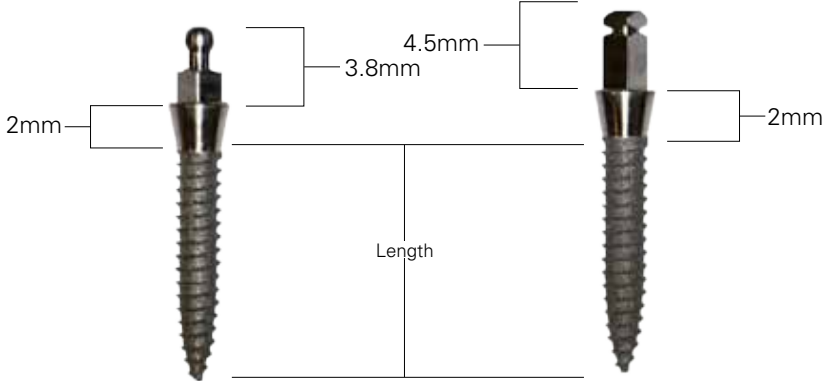
DIAMETER	CATALOG #	LENGTH	O-BALL/IOT ATTACHMENT HEAD	CROWN & BRIDGE HEAD
<b>[2.2 mm]</b>	I-MICRO 2210-CB	10.00mm		
	I-MICRO 2212-CB	12.00mm		
	I-MICRO 2214-CB	14.00mm		
	I-MICRO 2216-CB	16.00mm		
<b>All Sizes:</b> <b>\$49.00</b>	I-MICRO 2210-IOT	10.00mm		
	I-MICRO 2212-IOT	12.00mm		
	I-MICRO 2214-IOT	14.00mm		
	I-MICRO 2216-IOT	16.00mm		

<b>[2.5 mm]</b>	I-MICRO 2510-CB	10.00mm
	I-MICRO 2512-CB	12.00mm
	I-MICRO 2514-CB	14.00mm
	I-MICRO 2516-CB	16.00mm
<b>All Sizes:</b> <b>\$49.00</b>	I-MICRO 2510-IOT	10.00mm
	I-MICRO 2512-IOT	12.00mm
	I-MICRO 2514-IOT	14.00mm
	I-MICRO 2516-IOT	16.00mm

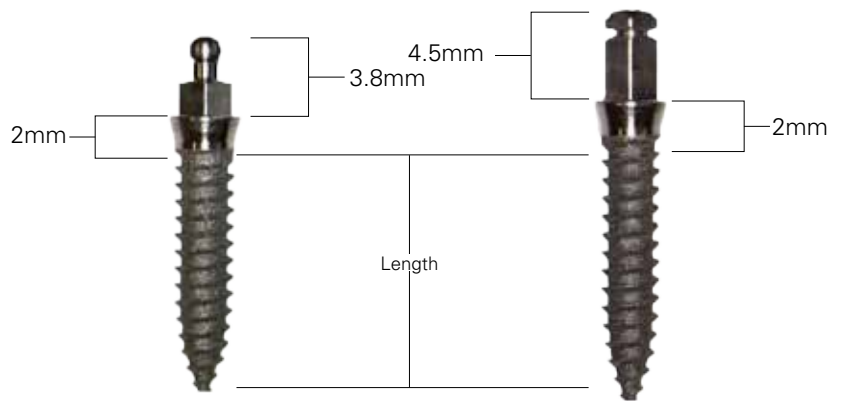

### I-MICRO DRIVERS



**3.0 & 3.25 mm  
C&B Driver (short)**  
MD-S  
\$82.00



**3.0 & 3.25 mm  
C&B Driver (long)**  
MD-L  
\$82.00



**Cementable Crown  
& Bridge Abutment**  
MCB  
\$30.00

# [I-MINI]

IMMEDIATE MINI IMPLANT



## **The 3.0mm I-Mini®**

The 3.0mm I-Mini is the perfect solution for denture stabilization or Crown & Bridge replacement when the patient's budget and bone quality are limited.

In 2002, The I-Mini® was the first one-piece 3.0mm "mini" implant introduced into the US market. After years of unparalleled success (better than 99.9% reported success rate) the I-Mini® is quickly becoming dentists' choice for small interdental space situations or denture stabilization.

The I-Mini® is the only mini on the market with a bull-nose auger tip designed to stimulate bone growth.

## IMMEDIATE MINI IMPLANTS

DIAMETER	CATALOG #	LENGTH	O-BALL/IOT ATTACHMENT HEAD	CROWN & BRIDGE HEAD
<b>[3.0 mm]</b>	I-MINI 3010-CB	10.00mm		
	I-MINI 3012-CB	12.00mm		
	I-MINI 3014-CB	14.00mm		
	I-MINI 3016-CB	16.00mm		
<b>All Sizes: \$69.00</b>	I-MINI 3010-IOT	10.00mm		
	I-MINI 3012-IOT	12.00mm		
	I-MINI 3014-IOT	14.00mm		
	I-MINI 3016-IOT	16.00mm		

### I-MINI™ DRIVERS



**3.0 & 3.25 mm**  
**O-ball Driver**  
0076  
\$82.00



**3.0 & 3.25 mm**  
**O-ball Driver (short)**  
0076S  
\$82.00



**3.0 & 3.25 mm**  
**C&B Driver**  
0083N  
\$82.00



**3.0 & 3.25 mm**  
**C&B Driver (short)**  
0083NS  
\$82.00

# [ISI]

IMMEDIATE STABILIZING IMPLANT



## **One-Piece, One Hour, One solution.**

If bone quality is optimal, use a one-piece implant designed to maximize stability and give your patient a temporary crown in less than an hour. The ISI Complete® one-piece implant has successfully challenged the dental industry's perceptions of implant placement and performance since its introduction in 2003.

With predictable immediate loading results (better than 99.9% reported success rate), a simple, flap-less placement protocol, and an economical price, the ISI Complete® implant is the dentists' choice for larger diameter one-piece immediate load implants. The collar and abutment are now available with a titanium nitride coating for improved esthetics.

**The Only**

**Dual Stabilization®  
Dental Implant System**

# IMMEDIATE STABILIZING IMPLANTS

DIAMETER	CATALOG #	LENGTH	CROWN & BRIDGE HEAD	IOT/O-BALL ATTACHMENT HEAD
<b>[3.25mm]</b>	ISI 32508 CB	8mm		
	ISI 32510 CB	10mm		
	ISI 32512 CB	12mm		
	ISI 32514 CB	14mm		
	ISI 32516 CB	16mm		
	ISI 32508 IOT	8mm		
	ISI 32510 IOT	10mm		
	ISI 32512 IOT	12mm		
	ISI 32514 IOT	14mm		
	ISI 32516 IOT	16mm		

**[3.25mm]**

**All Sizes:**

**\$149.00**

**[4.0mm]**

**All Sizes:**

**\$149.00**

**[5.0mm]**

**All Sizes:**

**\$149.00**

## ISI DRIVERS



**3.0 & 3.25 mm  
O-ball Driver**

0076  
\$82.00



**3.0 & 3.25 mm  
O-ball Driver (short)**

0076S  
\$82.00



**3.0 & 3.25 mm  
C&B Driver**

0083N  
\$82.00



**3.0 & 3.25 mm  
C&B Driver (short)**

0083NS  
\$82.00



**4.0 & 5.0 mm  
C&B Driver**

0075N  
\$82.00



**4.0 & 5.0 mm  
C&B Driver (short)**

0075NS  
\$82.00



**4.0 & 5.0 mm  
O-ball Driver/extension**

0091  
\$82.00

# [TSI]

## TWO-PIECE TAPER SCREW IMPLANT



### The two-piece stabilizing TSI

Whether you want your patient to go home with a temporary crown, or have them wait during a conventional healing period, the TSI was designed for immediate loading, delayed loading, and one-stage or two-stage surgical options.

The TSI can be paired with multiple abutments for several different restoration options. With the same dual stabilizing implant body and 2mm periolock collar as the ISI Complete®, the TSI can be placed in the anterior or posterior mandible/maxilla for aesthetic cases, immediate placements, single, or multiple tooth replacements or for denture stabilization with O-balls or Locator Attachments.

The collar and abutment are now available with a titanium nitride coating for improved esthetics.

The Only

Dual Stabilization®  
Dental Implant System

## TWO PIECE TAPER SCREW IMPLANTS

DIAMETER CATALOG # LENGTH

<b>[3.25mm]</b>	32508 TSI	8mm
	32510 TSI	10mm
	32512 TSI	12mm
	32514 TSI	14mm
	32516 TSI	16mm

**All Sizes:**  
**\$174.00**

\*1mm height healing screw included in TSI implant packaging.



<b>[4.0mm]</b>	4008 TSI	8mm
	4010 TSI	10mm
	4012 TSI	12mm
	4014 TSI	14mm
	4016 TSI	16mm

**All Sizes:**  
**\$174.00**

\*1mm height healing screw included in TSI implant packaging.



<b>[5.0mm]</b>	5008 TSI	8mm
	5010 TSI	10mm
	5012 TSI	12mm
	5014 TSI	14mm
	5016 TSI	16mm

**All Sizes:**  
**\$174.00**

\*1mm height healing screw included in TSI implant packaging.



### TSI DRIVERS



**3.25 mm**  
**Driver (long)**  
0013  
\$82.00



**3.25 mm**  
**Driver (short)**  
0014  
\$82.00



**4.0 & 5.0 mm**  
**Driver (long)**  
0011  
\$82.00



**4.0 & 5.0 mm**  
**Driver (short)**  
0012  
\$82.00

# [ERI]

ESTHETIC REGION IMPLANT



## The ERI

For esthetic cases, you want the best possible restorative outcome for your patient. The ERI has a 1mm titanium nitride coated periocollar collar to camouflage itself under the gingiva thus eliminating the grey titanium bleed-through. Designed to be placed slightly above bone level, the divergent collar eliminates bone loss seen in some of our competitor's bone level implants.

The ERI can be placed conventionally with healing cuffs, or in most cases, can allow the patient to receive a temporary tooth in less than an hour using one of our multiple abutment options.

The ERI's self tapping implant body is the same as the our ISI Complete® one-piece and TSI two-piece (with over 7 years of refinement and an unchallenged reported success rate). The ERI maximizes thread to bone fixation and is stabilized at the tip and collar through Dual Stabilization®, an industry unique design feature that allows for immediate loading.

The Only

Dual Stabilization®  
Dental Implant System

## ESTHETIC REGION IMPLANTS

DIAMETER CATALOG # LENGTH

### [3.25mm]

32508 ERI	8mm
32510 ERI	10mm
32512 ERI	12mm
32514 ERI	14mm
32516 ERI	16mm

**All Sizes:**  
**\$179.00**

\*1mm height healing screw included  
in ERI implant packaging.



### [4.0mm]

4008 ERI	8mm
4010 ERI	10mm
4012 ERI	12mm
4014 ERI	14mm
4016 ERI	16mm

**All Sizes:**  
**\$179.00**

\*1mm height healing screw included  
in TSI implant packaging.



### [5.0mm]

5008 ERI	8mm
5010 ERI	10mm
5012 ERI	12mm
5014 ERI	14mm
5016 ERI	16mm

**All Sizes:**  
**\$179.00**

\*1mm height healing screw included  
in ERI implant packaging.

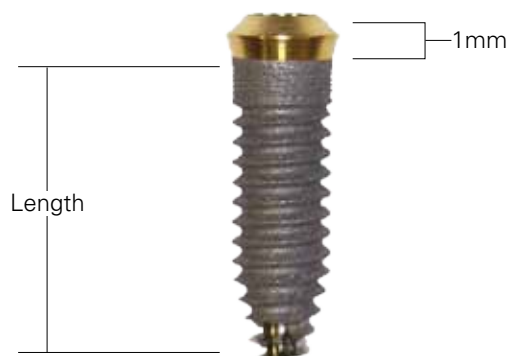

### ERI DRIVERS



**3.25 mm**  
**Driver (long)**  
0013  
\$82.00



**3.25 mm**  
**Driver (short)**  
0014  
\$82.00



**4.0 & 5.0 mm**  
**Driver (long)**  
0011  
\$82.00



**4.0 & 5.0 mm**  
**Driver (short)**  
0012  
\$82.00

# [SURGICAL KITS]

## PLACEMENT KITS FOR ALL OCO IMPLANTS



### OCO Complete Surgical Instrumentation System

#### Places All OCO Implants

ISH-MINI-TSI Surgical Kit

\$4,000.00

The OCO Biomedical Complete Surgical Kit is organized with the OCO color-coded system, to coincide with the implant placement procedures in an easy to follow, step-by-step format. All components are labeled for easy removal and return to the tray after each surgery. The kit's size and low profile allows it to fit easily into the autoclave for sterilization. There is also an extra compartment underneath the caddy which provides room for additional components and instruments when necessary.

#### The OCO Complete Surgical Kit includes:

- .050mm Hex driver (long)
- .050mm Hex driver (short)
- 1.5mm Pilot Drill
- 1.8mm Pilot Drill
- Drill Stops for Pilot Drill (4 included)
- 3.0 I-MINI® & 3.25 ISI/TSI C&B Driver (long)
- 3.0 I-MINI® & 3.25 ISI/TSI C&B Driver (short)
- 4.0 & 5.0 ISI/TSI C&B Driver (long)
- 4.0 & 5.0 ISI/TSI C&B Driver (short)
- Drill Extender
- 2.4 mm Final Drill (3.0 mm I-MINI® Final Drill)
- 2.8 mm Final Drill (Maxilla/Upper 3.25 mm)
- 3.0 mm Final Drill (Mandible/Lower 3.25 mm)
- 3.5 mm Final Drill (Maxilla/Upper 4.0 mm)
- 3.7 mm Final Drill (Mandible/Lower 4.0 mm)
- 4.5 mm Final Drill (Maxilla/Upper 5.0 mm)
- 4.7 mm Final Drill (Mandible/Lower 5.0 mm)
- Hand-piece Driver/Adapter
- ISI/TSI Driver Extension and 4.0 & 5.0 mm ISI/TSI O-Ball/IOT Driver
- 3.25mm Paralleling Pins (4 included)
- 4.0mm Paralleling Pins (4 included)
- 5.0mm Paralleling Pins (4 included)
- I-MINI® 3.0 and ISI/TSI 3.25 mm Countersink Drill
- ISI/TSI 4.0 mm Countersink Drill
- ISI/TSI 5.0 mm Countersink Drill
- ISI/TSI Instrumentation Tray
- Marking/Surgical Bur #8 - High Speed
- Thumb Knob Wrench
- 3.25 mm Tissue Punch
- 4.0 mm Tissue Punch
- 5.0 mm Tissue Punch
- 3.25 mm TSI Driver (long)
- 3.25 mm TSI Driver (short)
- 4.0 & 5.0 mm TSI Driver (long)
- 4.0 & 5.0 mm TSI Driver (short)
- 3.25 ISI/TSI & 3.0 I-MINI® IOT/O-Ball Driver
- 3.25mm ISI/TSI and 3.0mm I-MINI® IOT Driver (short)
- I-Micro Driver (long)
- I-Micro Driver (short)
- Torque Lock Wrench
- Ratchet Wrench



### Mini Surgical Instrumentation System

#### Places all OCO I-Micro & I-Mini® Implants

i-MINI Surgical Kit

\$1,400.00

The Mini Surgical Instrumentation System is an economical surgical kit designed specifically for our 2.2 and 2.5mm I-Micro and the 3.0mm I-Mini® Dental Implants. The kit includes all the instrumentation you need to place our unique one-piece mini implants.

All components are labeled for easy removal and return to the tray after each surgery. The kit's size and low profile allow it to fit easily into the autoclave for sterilization. There is also an extra compartment underneath the caddy which provides room for additional components and instruments when necessary.

#### The Mini Surgical Kit includes:

- Instrumentation Tray
- #8 Marking Bur
- 1.5mm Pilot Drill
- 1.8mm Pilot Drill
- Drill Stops for Pilot Drill (4 included)
- 3.5 mm Tissue Punch
- 2.4 mm Final Drill
- 3.0 mm Crown & Bridge Drivers (long & short)
- 3.0 mm O-Ball/IOT Drivers (long & short)
- I-Micro Driver (long)
- I-Micro Driver (short)
- 3.0 mm Paralleling Pins (4)
- Thumb Knob Wrench
- Ratchet Wrench

Please see page 27 for product sterilization information

# [INSTRUMENTATION]

**ITEM**  
CATALOG#  
PRICE



**Marking Bur #8  
High Speed**

#8 HS  
\$15.00



**Pilot Drill  
1.5 & 1.8mm**

1.5mm - 0150  
1.8mm - 0180  
\$62.00  
Use the 1.5mm Drill for  
the 2.2mm I-Micro



**Drill Stops  
for Pilot Drill**

DS0180-8 DS0180-10  
DS0180-12 DS0180-14  
DS-Kit (all 4)  
\$25.00 each  
\$100.00 kit



**Paralleling Pin  
3.25 mm**

ISI-P 3.25  
\$22.00



**Paralleling Pin  
4.0 mm**

ISI-P 4.0  
\$22.00



**Paralleling Pin  
5.0 mm**

ISI-P 5.0  
\$22.00



**Tissue Punch  
3.25 mm**

0062  
\$120.00  
Places the 3.0mm I-Mini  
& 3.25mm ISI/TSI



**Tissue Punch  
4.0 mm**

0063  
\$120.00



**Tissue Punch  
5.0 mm**

0065  
\$120.00

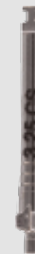

**Countersink drill  
3.25 mm**

3.25 CS  
\$120.00  
For the ISI and TSI  
Implants  
\*not always required



**Countersink drill  
4.0 mm**

4.0 CS  
\$120.00  
For the ISI and TSI  
Implants  
\*not always required

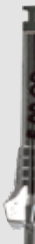

**Countersink drill  
5.0 mm**

5.0 CS  
\$120.00  
For the ISI and TSI  
Implants  
\*not always required



**Osteotomy Former  
2.4mm**

K-0240T  
\$124.00  
For Placement of the  
3.0 mm I-Mini



**Osteotomy Former  
2.8mm**

K-0280T  
\$124.00  
For Placement of the  
3.25mm ISI/TSI/ERI  
Maxillary Final Drill



**Osteotomy Former  
3.0mm**

K-0300T  
\$124.00  
For Placement of the  
3.25mm ISI/TSI/ERI  
Mandibular Final Drill



**Osteotomy Former  
3.5mm**

K-0350T  
\$124.00  
For Placement of the  
4.0mm ISI/TSI/ERI



**Osteotomy Former  
3.7mm**

K-0370T  
\$124.00  
For Placement of the  
4.0mm ISI/TSI/ERI  
Mandibular Final Drill



**Osteotomy Former  
4.5mm**

K-0450T  
\$124.00  
For Placement of the  
5.0mm ISI/TSI/ERI  
Maxillary Final Drill



**Osteotomy Former  
4.7mm**

K-0470T  
\$124.00  
For Placement of the  
5.0mm ISI/TSI/ERI  
Mandibular Final Drill















**Osteotomes**

Straight Osteotomes: \$89.00  
OST 1.8 1.8 mm diameter  
OST 2.65 2.65 mm diameter  
OST 3.4 3.4 mm diameter  
OST 4.4 4.4 mm diameter  
OST-Kit - All 4 w/ case \$395.00  
Offset Osteotomes: \$89.00  
OST-OS 1.8 1.8 mm diameter  
OST-OS 2.65 2.65 mm diameter  
OST-OS 3.4 3.4 mm diameter  
OST-OS 4.4 4.4 mm diameter  
OST-OS-Kit - All 4 w/ case \$395.00

Please see page 27 for product sterilization information















# [INSTRUMENTATION]

 <p><b>Thumb Knob Driver/Wrench</b> TK \$45.00</p>	 <p><b>Handpiece Driver/Adapter</b> 0097 \$80.00</p>	 <p><b>TSI /ERI Driver 3.25mm</b> 0013 0014 (short) \$82.00 Places the 3.25mm TSI &amp; ERI Implants</p>	 <p><b>TSI /ERI Driver 4.0 &amp; 5.0mm</b> 0011 0012 (short) \$82.00 Places the 4.0 &amp; 5.0mm TSI &amp; ERI Implants</p>	 <p><b>Ratchet Wrench</b> RW \$145.00</p>
 <p><b>C&amp;B Driver 3.0 &amp; 3.25 mm</b> 0083N 0083NS (short) \$82.00 Places the I-Mini and ISI C&amp;B Implants Engages 3.25mm solid abutments with TSI/ERI</p>	 <p><b>C&amp;B Driver 4.0 &amp; 5.0 mm</b> 0075N 0075NS (short) \$82.00 Places the I-Mini and ISI C&amp;B Implants Engages 4.0/5.0mm solid abutments with TSI/ERI</p>	 <p><b>O-ball Driver 3.0 &amp; 3.25 mm</b> 0076 0076S (short) \$82.00 Places the I-Mini and ISI O-Ball Implants Engages 3.25, 4.0, &amp; 5.0mm solid abutments with TSI/ERI</p>	 <p><b>I-Micro Driver 2.2 &amp; 2.5 mm</b> MD-L (long) MD-S (short) \$82.00 Places both C&amp;B and O-Ball I-Micros</p>	
 <p><b>Hex Driver .050mm</b> .050 L (long) .050 S (short) \$45.00</p>	 <p><b>ISI O-ball Driver 4.0/5.0mm</b> 0091 \$82.00 Also a driver extension</p>	 <p><b>Locator Square Drive Tool (Short) 15mm</b> 8926 \$44.00 Driver for Locator Abutments</p>	 <p><b>Locator Square Drive Tool (long) 21mm</b> 8927 \$44.00 Driver for Locator Abutments</p>	 <p><b>Torque Lock Wrench</b> 6101 \$450.00</p>
 <p><b>Angle Measurement Guide</b> 9530 \$21.00</p>	 <p><b>Locator Parallel Post</b> 8517 4 pack \$16.00</p>	 <p><b>Locator Core Tool</b> 8393 \$75.00 Places the Locator Abutments and Replacement Males</p>	 <p><b>Locking Holder</b> 0077 \$125.00</p>	
 <p><b>Profiling Burr for TSI/ERI</b> 3.25mm - 0098 4.00mm - 0099 5.00mm - 0100 \$82.00</p>	 <p><b>Ridge Mapping Caliper</b> Ridge Mapping Caliper \$138.00</p>			

Please see page 27 for product sterilization information

# [ABUTMENTS]

FOR TSI & ERI IMPLANTS

				<b>ITEM</b>
				<b>CATALOG#</b>
				<b>PRICE</b>
 <p><b>Fixed Solid C&amp;B Abutment 3.25mm (4mm height)</b></p> <p>3.25CB 4TSI \$70.00 Engages in the 3.25mm TSI &amp; ERI Implants</p>	 <p><b>Fixed Solid C&amp;B Abutment 3.25mm (5.5mm height)</b></p> <p>3.25CB 5.5TSI \$70.00 Engages in the 3.25mm TSI &amp; ERI Implants</p>	 <p><b>Fixed Solid C&amp;B Abutment 3.25mm (7mm height)</b></p> <p>3.25CB 7TSI \$70.00 Engages in the 3.25mm TSI &amp; ERI Implants</p>		
 <p><b>Fixed Solid O-Ball Abutment 3.25mm (0mm height)</b></p> <p>3.25IOT 0TSI \$75.00 Engages in the 3.25mm TSI &amp; ERI Implants</p>	 <p><b>Fixed Solid O-Ball Abutment 3.25mm (2mm height)</b></p> <p>3.25IOT 2TSI \$75.00 Engages in the 3.25mm TSI &amp; ERI Implants</p>	 <p><b>Fixed Solid O-Ball Abutment 3.25mm (3mm height)</b></p> <p>3.25IOT 3TSI \$75.00 Engages in the 3.25mm TSI &amp; ERI Implants</p>	 <p><b>Fixed Solid O-Ball Abutment 3.25mm (4mm height)</b></p> <p>3.25IOT 4TSI \$75.00 Engages in the 3.25mm TSI &amp; ERI Implants</p>	
 <p><b>Fixed Solid Abutment 4.0 &amp; 5.0mm (4mm height)</b></p> <p>4CB 4TSI \$70.00 Engages in the 4.0/5.0mm TSI &amp; ERI Implants</p>	 <p><b>Fixed Solid Abutment 4.0 &amp; 5.0mm (5.5mm height)</b></p> <p>4CB 5.5TSI \$70.00 Engages in the 4.0/5.0mm TSI &amp; ERI Implants</p>	 <p><b>Fixed Solid Abutment 4.0 &amp; 5.0mm (7mm height)</b></p> <p>4CB 7TSI \$70.00 Engages in the 4.0/5.0mm TSI &amp; ERI Implants</p>		
 <p><b>Fixed Solid O-Ball Abutment 4.0 &amp; 5.0mm (0mm height)</b></p> <p>4IOT 0TSI \$75.00 Engages in the 4.0/5.0mm TSI &amp; ERI Implants</p>	 <p><b>Fixed Solid O-Ball Abutment 4.0 &amp; 5.0mm (2mm height)</b></p> <p>4IOT 2TSI \$75.00 Engages in the 4.0/5.0mm TSI &amp; ERI Implants</p>	 <p><b>Fixed Solid O-Ball Abutment 4.0 &amp; 5.0mm (3mm height)</b></p> <p>4IOT 3TSI \$75.00 Engages in the 4.0/5.0mm TSI &amp; ERI Implants</p>	 <p><b>Fixed Solid O-Ball Abutment 4.0 &amp; 5.0mm (4mm height)</b></p> <p>4IOT 4TSI \$75.00 Engages in the 4.0/5.0mm TSI &amp; ERI Implants</p>	

Please see page 27 for product sterilization information

# [ ABUTMENTS ]

FOR TSI & ERI IMPLANTS



**Locator Abutment  
3.25mm  
(0.7mm - 6.0mm)**

00.7mm - 1892 TSI-ERI  
2.00mm - 1893 TSI-ERI  
3.00mm - 1894 TSI-ERI  
4.00mm - 1895 TSI-ERI  
5.00mm - 1896 TSI-ERI  
6.00mm - 1897 TSI-ERI  
\$110.00  
Engages in the 3.25mm  
TSI & ERI Implants



**Locator Abutment  
4.0mm  
(2.0mm - 6.0mm)**

2.00mm - 8950 TSI-ERI  
3.00mm - 8951 TSI-ERI  
4.00mm - 8953 TSI-ERI  
5.00mm - 8964 TSI-ERI  
6.00mm - 8955 TSI-ERI  
\$110.00  
Engages in the 4.00mm  
TSI & ERI Implants



**Locator Abutment  
5.0mm  
(2.0mm - 6.0mm)**

2.00mm - 1898 TSI-ERI  
3.00mm - 1899 TSI-ERI  
4.00mm - 1900 TSI-ERI  
5.00mm - 1901 TSI-ERI  
6.00mm - 1902 TSI-ERI  
\$110.00  
Engages in the 5.00mm  
TSI & ERI Implants



**Straight Shielded  
Abutment  
3.25mm | 4.0mm | 5.0mm**

3.25mm - 3150 TSI  
4.00mm - 4150 TSI S (short)  
4.00mm - 4150 TSI L (long)  
5.00mm - 5150 TSI S (short)  
5.00mm - 5150 TSI L (long)  
\$85.00



**Natural Contour  
Abutment  
3.25mm | 4.0mm | 5.0mm**

3.25mm - 3350 TSI-ERI  
4.00mm - 4350 TSI-ERI  
5.00mm - 5350 TSI-ERI  
\$115.00  
Engages in the  
3.25mm - 5.00mm  
TSI & ERI Implants



**Straight Pedestal  
Abutment  
3.25mm | 4.0mm | 5.0mm**

3.25mm - 3100 TSI  
4.00mm - 4100 TSI  
5.00mm - 4100 TSI  
\$85.00



**Offset Pedestal 15°  
Abutment  
3.25mm | 4.0mm | 5.0mm**

3.25mm - 3200 TSI  
4.00mm - 4200 TSI  
5.00mm - 4200 TSI  
\$100.00



**Offset Shielded 15°  
Abutment  
3.25mm | 4.0mm | 5.0mm**

3.25mm - 3250 TSI S (short)  
3.25mm - 3250 TSI L (long)  
4.00mm - 4250 TSI S (short)  
4.00mm - 4250 TSI L (long)  
5.00mm - 5250 TSI S (short)  
5.00mm - 5250 TSI L (long)  
\$100.00



**Healing Cuffs  
TSI/ERI  
(2.0mm & 3.0mm Height)**

2.00mm Height  
3062 TSI HC (3.25mm dia.)  
4062 TSI HC (4.00mm dia.)  
5062 TSI HC (5.00mm dia.)  
  
3.00mm Height  
3063 TSI HC (3.25mm dia.)  
4063 TSI HC (4.00mm dia.)  
5063 TSI HC (5.00mm dia.)  
\$30.00



**Healing Cuffs  
TSI/ERI  
(4.0mm & 5.0mm Height)**

4.00mm Height  
3064 TSI HC (3.25mm dia.)  
4064 TSI HC (4.00mm dia.)  
5064 TSI HC (5.00mm dia.)  
  
5.00mm Height  
3065 TSI HC (3.25mm dia.)  
4065 TSI HC (4.00mm dia.)  
\$30.00



**Custom Abutment  
Healing Cuffs  
3.25mm | 4.0mm | 5.0mm**

3.25mm - 3.25 TSI CA-HC  
4.00mm - 4.0 TSI CA-HC  
5.00mm - 5.0 TSI CA-HC  
\$30.00  
Part of the Custom Abutment  
System



**Custom Abutment  
TSI/ERI  
3.25mm | 4.0mm | 5.0mm**

3.25mm - 3.25 CA  
4.00mm - 4 CA  
5.00mm - 4 CA  
\$55.00  
Part of the Custom Abutment  
System



**UCLA Impression Pickup  
TSI/ERI  
3.25mm | 4.0mm | 5.0mm**

3.25mm - 3.25 IP UCLA TSI  
4.00mm - 4.0 IP UCLA TSI  
5.00mm - 5.0 IP UCLA TSI  
\$35.00  
Part of the Custom Abutment  
System



**Bio-Torq Octagon Tip  
TSI/ERI  
3.25mm | 4.0mm | 5.0mm**

3.25mm - \*0084  
4.00mm - \*0094  
5.00mm - \*0094  
\$80.00  
Part of the Custom Abutment  
System



**Engaging Waxing  
Sleeves TSI/ERI  
3.25mm | 4.0mm | 5.0mm**

3.25 TSI-O (3.25mm dia.)  
4 TSI-O (4.00mm dia.)  
5 TSI-O (5.00mm dia.)  
\$35.00  
Part of the Custom Abutment  
Procedure



**Non-Engaging Waxing  
Sleeves TSI/ERI  
3.25mm | 4.0mm | 5.0mm**

3.25 TSI-NO (3.25mm dia.)  
4 TSI-NO (4.00mm dia.)  
5 TSI-NO (5.00mm dia.)  
\$35.00  
Part of the Custom Abutment  
Procedure

Please see page 27 for product sterilization information

# [RESTORATIVE KITS]

## O-Ball Attachment Head Kits

### ISI O-BALL ATTACHMENT HEAD [IOT KIT]

#### ISI-I-MINI-TSI IOT Kit

**3.0 / 3.25mm | 4.0mm | 5.0mm**

3.00mm - ISI 3.0 / 3.25mm IOT Kit

3.25mm - ISI 3.0 / 3.25mm IOT Kit

4.00mm - ISI 4.00mm IOT Kit

5.00mm - ISI 5.00mm IOT Kit

\$34.00

- 1 Encapsulator (003 Cap)
- 2 IOT/O-Ball Analog (3.0/3.25, 4.0 or 5.0mm)
- 3 Red Processing O-Ring - less retentive (003 Red)
- 4 Black Final O-Ring (003 Blk)



### TSI O-BALL ATTACHMENT HEAD [IOT KIT]

#### TSI 4.0 IOT Kit

**4.0mm | 5.0mm**

4.0mm - TSI 4.0 IOT Kit

5.0mm - TSI 4.0 IOT Kit

\$34.00

- 1 Encapsulator (003 Cap)
- 2 TSI O-Ball Analog (4.0 or 5.0mm)
- 3 Red Processing O-Ring - less retentive (003 Red)
- 4 Black Final O-Ring (003 Blk)

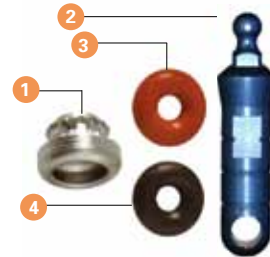

### LOCATOR MALE PROCESSING KIT

#### Locator Male Processing Kit

Catalog #: 8519

Includes denture cap with black processing male, block-out spacer, & replacement males (blue, pink, clear).

Qty. 2 packs

\$58.00

- 1 Denture Cap with black processing male
- 2 Block-Out Spacer
- 3 Replacement Males

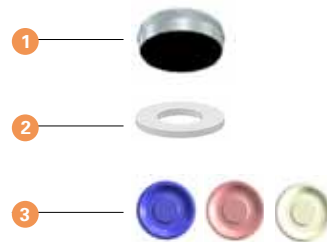

## Analogs, Analog Tools & Impression Copings

**ITEM**  
CATALOG#  
PRICE



**Margin Analog Tool**  
**3.0 / 3.25mm | 4.0mm | 5.0mm**

- 3.00mm - MAT 3.25
- 3.25mm - MAT 3.25
- 4.00mm - MAT 4.0
- 5.00mm - MAT 5.0
- \$20.00

**Margin Analog**  
**3.0 / 3.25mm | 4.0mm | 5.0mm**

- 3.00mm - 3.25 MA
- 3.25mm - 3.25 MA
- 4.00mm - 4.0 MA
- 5.00mm - 5.0 MA
- \$15.00



**C&B Analog**  
**2.20mm - 5.0mm**

- 2.20mm - MTA
- 2.50mm - MTA
- 3.00mm - ISH-MINIA CB
- 3.25mm - ISH-MINIA CB
- 4.00mm - ISIA 4.0 CB
- 5.00mm - ISIA 5.0 CB
- \$18.00



**ISI O-Ball IOT Analog**  
**2.20mm - 5.0mm**

- 2.20mm - MTA
- 2.50mm - MTA
- 3.00mm - ISH-MINIA IOT
- 3.25mm - ISH-MINIA IOT
- 4.00mm - ISIA 4.0 IOT
- 5.00mm - ISIA 5.0 IOT
- \$18.00



**TSI/ERI Analog**  
3.25mm - TSIA 3.25  
4.00mm - TSIA 4.0  
5.00mm - TSIA 5.0  
\$25.00



**Custom Abutment Analog**  
**TSI/ERI**  
3.25mm- 325A CA TSI  
4.00mm - 4.0A CA TSI  
5.00mm - 5.0A CA TSI  
\$25.00



**C&B TRIP**  
**(tissue retraction impression pickup)**  
**2.20mm to 5.0mm**  
2.20mm - MIC  
2.50mm - MIC  
3.00mm - ISH-MINIC  
3.25mm - ISH-MINIC  
4.00mm - ISIC 4.0  
5.00mm - ISIC 5.0  
\$15.00



**TSI / ERI Offset TRIP**  
**(tissue retraction impression pickup)**  
**3.25mm | 4.0mm | 5.0mm**  
3.25mm - TSI-OS 3.25  
4.00mm - TSI-OS 4.0  
5.00mm - TSI-OS 5.0  
\$15.00



**Acrylic Coping**  
**2.20mm to 5.0mm**  
2.20mm - MAC  
2.50mm - MAC  
3.00mm - ISH-MINI AC  
3.25mm - ISH-MINI AC  
4.00mm - 4.0 AC  
5.00mm - 5.0 AC  
\$15.00



**TSI / ERI Indexing Impression Coping**  
**3.25mm | 4.0mm | 5.0mm**  
3.25mm - 3.25 IC  
4.00mm - 4.0 IC  
5.00mm - 5.0 IC  
\$20.00



**Locator**  
**Impression Coping**  
8505  
4 pack  
\$63.00



**Locator**  
**Female Analog**  
**4mm**  
8530  
4 pack  
\$63.00

# [CASTABLE COMPONENTS]

## OVERDENTURE & SUBPERIOSTEAL ATTACHMENTS

CATALOG #

PRICE

### [MINI]

1	002 Encapsulator (002 Cap)	\$12.00
2	002 Paralleling Mandrel (002 Mandrel)	\$8.00
3	Pin for Mandrels (Mandrel Pin)	\$4.00
4	002 Straight Post (002 Post)	\$6.00
5	002 Distal Extension Post (002 DX Post)	\$6.00
6	002 Red "O" Ring (002 Red)	\$20.00 for 10
7	002 Black "O" Ring (002 Blk)*	\$20.00 for 10

\*Also available 90 Durometer Hardness Black "O" Ring (003BN90)



### [LOWHEAD]

1	003 Cap (003 Cap)	\$12.00
2	003 Retaining Ring	\$12.00
3	003 Paralleling Mandrel (003 Mandrel)	\$8.00
4	Pin for Mandrels (Mandrel Pin)	\$4.00
5	003 Straight Post (003 Post)	\$6.00
6	003 Distal Extension Post (003 DX Post)	\$6.00
7	003 Red "O" Ring (003 Red)	\$20.00 for 10
8	003 Black "O" Ring (003 Blk)*	\$20.00 for 10
9	003 White "O" Ring (003 Wht)	\$20.00 for 10

\*Also available 90 Durometer Hardness Black "O" Ring (003BN90)

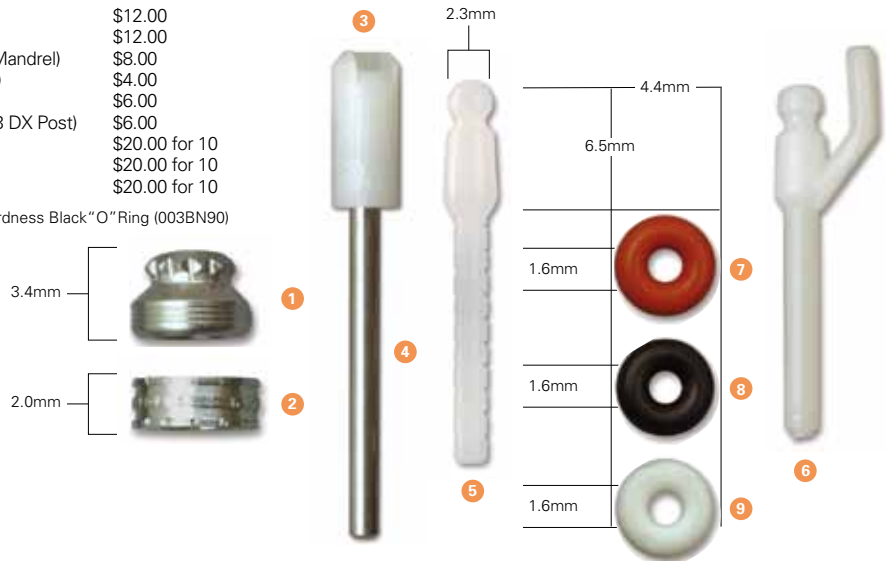

O-Ring Placement Tool

DX Distal Extension Attachments

Places 002 & 003 O-Rings in corresponding caps

O-Ring IT  
\$25.00



- Simplest cost effective attachment in use today
- Clasless partial denture attachments
- Distal or Mesial Attachment



# [CASTABLE COMPONENTS]

## OVERDENTURE & SUBPERIOSTEAL ATTACHMENTS

CATALOG #

PRICE

[LARGE]

- 1 005 Encapsulator (005 Cap) \$12.00
- 2 005 Paralleling Mandrel (005 Mandrel) \$8.00
- 3 Pin for Mandrels (Mandrel Pin) \$4.00
- 4 005 Straight Post (005 Post) \$6.00
- 5 005 Red "O" Ring (005 Red) \$20.00 for 10
- 6 005 Black "O" Ring (005 Blk) \$20.00 for 10



### LOCATOR INSERTS

ITEM	Replacement Male, 5lbs. (Clear)	Replacement Male, Light Retention, 3lbs. (Pink)	Replacement Male, Extra Light Retention, 1.5lbs. (Blue)	Extended Range Replacement Male, 4lbs. (Green)
CATALOG#	8524	8527	8529	8547
QTY.	4 pack	4 pack	4 pack	4 pack
PRICE		\$21.00	\$21.00	\$21.00
	Extended Range Replacement Male, 2lbs. (Orange)	Extended Range Replacement Male, Extra Light Retention, 3lbs. (Red)	Block Out Spacers	
	8915	8548	8514	
	4 pack	4 pack	20 pack	
	\$21.00	\$21.00	\$16.00	

## NATURAL TOOTH ROOT OVERDENTURE ATTACHMENTS

### MINI (002)/LOWHEAD (003)

SHANK WIDTH	CATALOG #	LENGTH	PRICE	MINI (002)	LOWHEAD (003)
[2.16mm]	002AITA	10.5mm	\$43.00		
[1.60mm]	002AITB	13.75mm	\$43.00		
[2.16mm]	003AITA	11.24mm	\$43.00		
[1.60mm]	003AITB	14.22mm	\$43.00		

Please see page 27 for product sterilization information

### INSTRUMENTATION

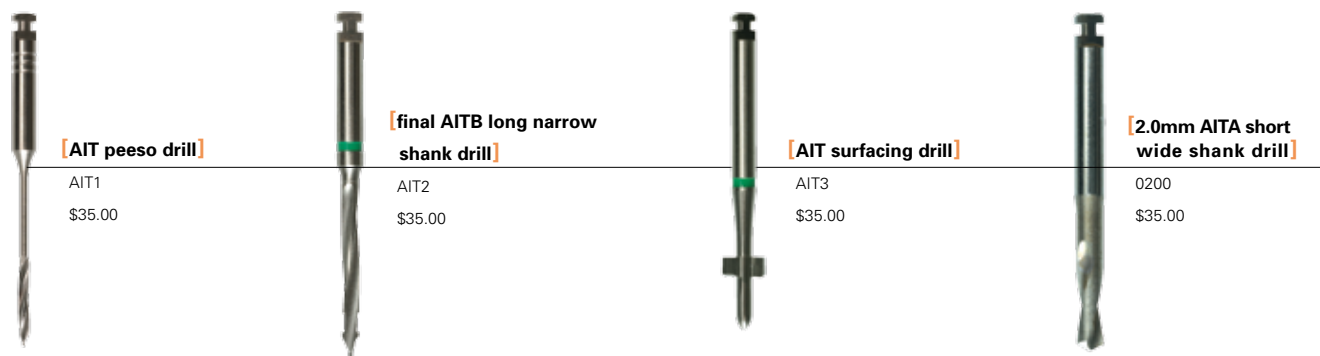

### COMPLETE AIT KIT

**Mini AIT Kit**  
(002 Oring Kit)  
\$22.00

- 1 Straight Post (002 Post)
- 2 Encapsulator (002 Cap)
- 3 Red Processor "O" Ring (002 Red)
- 4 Black Final "O" Ring (002 Blk)

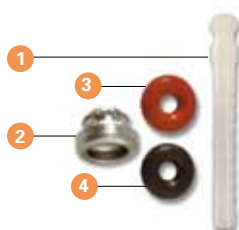

**Lowhead AIT Kit**  
(003 Oring Kit)  
\$22.00

- 1 Straight Post (003 Post)
- 2 Encapsulator (003 Cap)
- 3 Red Processor "O" Ring (003 Red)
- 4 Black Final "O" Ring (003 Blk)



# [ADDITIONAL PRODUCTS]

Aseptic Products

## ITEM

CATALOG#  
SPEED RANGE  
MAX TORQUE



### Mont Blanc, 20:1 Reduction Contra Angle with Adjustable Depth Stop and Gauge

AHP-85MB-CX  
80 Ncm  
15 - 2,000  
Contact OCO for Pricing



### Mont Blanc, 20:1 Reduction Contra Angle

AHP-85MB-X  
80 Ncm  
15 - 2,000  
Contact OCO for Pricing



### 20:1 Reduction Contra Angle

AHP-85P-I  
55 Ncm  
15 - 2,000  
Contact OCO for Pricing



## AEU-7000-70V

- Powerful brushless 40,000 rpm autoclavable micromotor
- Variable ratio selection: 1:5, 1:2, 1:1, and 20:1 E-type handpieces
- Adjustable torque up to 60 Ncm enables a single, high-efficiency 20:1 reduction handpiece (AHP-85MB or AHP-85MB-C) to be used for the complete implant procedure.
- Advanced dynamometer calibration system accurately measures the properties of the micromotor & handpiece prior to use.
- Selectable auto-stop function when desired torque setting is reached.
- Contemporary design with easily cleaned surfaces.
- Fully integrated, easy-load irrigation pump
- Large, bright, easy-to-read display
- Intuitive user interface that features adjustable handpiece ratio, speed, torque, and irrigation flow settings.
- Six programmable preset buttons for storing and labeling custom settings in memory. Presets may be labeled according to technique-specific preferences.
- Includes AE-70V Multi-Function Foot Control and irrigation tubing set.

Contact OCO for Pricing



## AEU-6000-70V

- Switch between Endo Mode and Implant Mode at the touch of a button
- Powerful brushless 40,000 rpm autoclavable micromotor
- Implant mode ratio selection: 1:5, 1:2, 1:1 and 20:1
- Endo mode: 8:1
- Calibration technology for accurate speed and torque performance
- Adjustable torque:
- Selectable Auto-stop function in Implant Mode and Auto-Stop-Reverse in Endo Mode when desired torque setting is reached
- Fully integrated, easy-load irrigation pump
- Large, bright, easy-to-read display
- Intuitive user interface that features adjustable handpiece ratio, speed, torque, and irrigation flow settings
- Five programmable preset buttons for storing and labeling custom settings in memory.
- Autoclavable motor holder may be free-standing or mounted to either side of the console
- Upgradeable software for a longer return on investment
- Includes AE-70V variable speed/multi-function foot control with Pump On/Off, Micromotor Direction, Preset Selection, and Torque Cycle buttons
- Autoclavable tubing set for standard irrigation bags;
- Optional tubing set accommodates rigid irrigation bottles
- Auto-sensing global voltage compatibility

Contact OCO for Pricing

# [QUESTIONS & ANSWERS]

## HOW LONG WILL IT TAKE FOR MY SHIPMENT TO ARRIVE?

UPS® Ground Shipping is guaranteed to be delivered within five business days. Other options include UPS® Overnight, Second and Third-Day delivery. FedEx® services are also available upon request.

## WHAT IS YOUR RETURN POLICY?

Authorizations for returns must be requested from OCO Biomedical prior to return of any product. Please call 800-228-0477 (+505-293-0025 international), or email [returns@ocobiomedical.com](mailto:returns@ocobiomedical.com) for return authorization or for questions regarding returns.

Product returned must be in new and unused condition (returned in the original packaging), and must be received within 60 days of the invoice date. No cash refunds. Original invoice number and purchase date must accompany product in order to process the return. Returned products may be subject to a 15% restocking fee. Please note that the returned product must be enclosed in safe, protective packaging such as a padded envelope or box. Sterilized products will not be accepted for return if the product's packaging has been opened. Please include the Return Authorization Number on the outside of the package.

## DO YOU HAVE AN IMPLANT WARRANTY?

OCO Biomedical Dental Implants are warranted unconditionally against defects in material and workmanship. The warranty covers only the cost of the implant and abutment and does not cover professional fees. If a defect is found, please do not use the item. Simply return the item after notifying OCO Biomedical, and a replacement item will be delivered at no additional charge. OCO Biomedical Dental Implants are conditionally warranted if failure occurs within 5 years after placement, and will be replaced at one third the current retail price, plus shipping, provided that: the implant was used with an OCO Biomedical abutment and the implant and abutment, if applicable, are returned to OCO Biomedical accompanied by a completed "Failed Implant Report", including lot number. (A "Failed Implant Report" may also be obtained through the returns department.)

## DOES OCO BIOMEDICAL HAVE TRAINING SEMINARS?

OCO Biomedical offers Simple Implant Placement and Restoration Courses at our headquarters in Albuquerque, NM and starting in 2011 our courses will be offered bimonthly in cities all over North America. Please call 800-228-0477 or go to our website, [www.ocobiomedical.com](http://www.ocobiomedical.com) for more training and scheduling information.

## HOW CAN I ORDER YOUR PRODUCTS?

You can order online at [www.ocobiomedical.com](http://www.ocobiomedical.com), fax your order to 505-293-0447, or call our sales department at 800-228-0477.

## PRODUCT STERILIZATION DISCLAIMER

**Implants:** OCO Biomedical does not recommend the re-sterilization of implants after they have been removed from the vial or placed in the jaw because of the possibility of the transference of blood borne pathogens or other contaminants.

**All other surgical instrumentation:** OCO Biomedical recommends using a steam sterilization unit at 121 degrees Celsius for 15 minutes with a drying time of 30 minutes.



# **OCO BIOMEDICAL**

8500 Washington St. NE, Suite A-1, Albuquerque, NM 87113  
800.228.0477 | 505.293.0025 | Fax 505.293.0047 | [ocobiomedical.com](http://ocobiomedical.com) | [sales@ocobiomedical.com](mailto:sales@ocobiomedical.com)